



# ***Yukon Gear & Axle®***

## **D60 Hardcore Locking Hub Installation Guide**

PLEASE READ COMPLETELY BEFORE INSTALLATION



## **D60 Hardcore Locking Hub Installation Instructions**

### **APPLICATION GUIDE:**

#### **YHC70001** – D60 35spl

- '79-'93 Dodge internal flange design
- '79-'91 GM
- '78-'97 Ford

#### **YHC70002** – D60 35spl

- '99-'04 Ford Superduty, aftermarket unit bearings

#### **YHC70003** – D60 30spl

- '75-'93 Dodge D60 internal flange design only
- '77-'91 GM D60
- '78-'97 Ford F350

#### **YHC70004** – D60 30spl

- '99-'04 Ford Superduty

#### **YHC70008** –

- Spin Free 35spl
- '94-'99 Dodge SRW with Spin Free or EMS kit

#### **YHC70009** –

- Spin Free 35spl
- '00-'08 Dodge SRW, DRW with Spin Free or EMS kit (35 spline)

### **SUPPORTING VEHICLE:**

Before starting work on the vehicle make sure it is properly supported with suitable lifting equipment and secured to prevent unwanted movement.

### **SUBMERSION:**

If the hubs become submersed in water or mud, they will need to be disassembled, cleaned and re-greased on each occurrence. Improper maintenance will prevent proper hub function.

### **CAUTION:**

**LOCK-OUTS SHOULD ALWAYS BE DISENGAGED WITH THE VEHICLE ON LEVEL SURFACE WITH PARKING BRAKE SET TO PREVENT VEHICLE FROM ROLLING.**

**ALWAYS SHIFT TRANSFER CASE TO 2WD OR NEUTRAL BEFORE DISENGAGING THE LOCK-OUTS.**

**CHECK STUB AXLE FOR PLAY SIDE TO SIDE, UP AND DOWN. A WORN SPINDLE TO AXLE BEARING CAN RESULT IN IMPROPER LOCK-OUT ENGAGEMENT/DISENGAGEMENT.**

## **D60 Hardcore Locking Hub Installation Instructions**

SOME RESIDUAL DRIVELINE "WRAP-UP" WILL BE PRESENT AFTER FOUR-WHEEL DRIVE OPERATION. IF THE LOCK OUTS OR TRANSFER CASE ARE DIFFICULT TO MOVE, DRIVING THE VEHICLE A FEW FEET FORWARD OR BACKWARD OR MOVING THE STEERING WHEEL FROM SIDE TO SIDE WILL NORMALLY REMOVE SOME OF THE WRAP-UP AND EASE MOVEMENT.

### **ASSEMBLY INSTRUCTIONS**

1. Remove existing lock-out or flange assembly if applicable. See the manufacturer's instructions for proper removal.

*Note: See page 11 for the component list, descriptions and exploded view of the Yukon D60 Locking Hubs.*

2. With the existing lock-out assembly removed, your stub axle and locking spindle nuts should be visible inside the hub if being installed onto a standard hub, spindle assembly. If bearing service is required now is a good time to remove, repack and replace the wheel bearings. Proper bearing preload and setup is critical to the life of the bearings and the function of the wheel hub, lockout assembly.



## **D60 Hardcore Locking Hub Installation Instructions**

---

3. If being installed into a unit bearing assembly the axle and inner portion of the unit bearing, snap ring, and washers should be visible.

*Note: The OEM supplied washer and snap ring assembly is required for use in all unit bearing applications. Acquire the needed washers and snap ring from the OEM supplier if they are not present.*

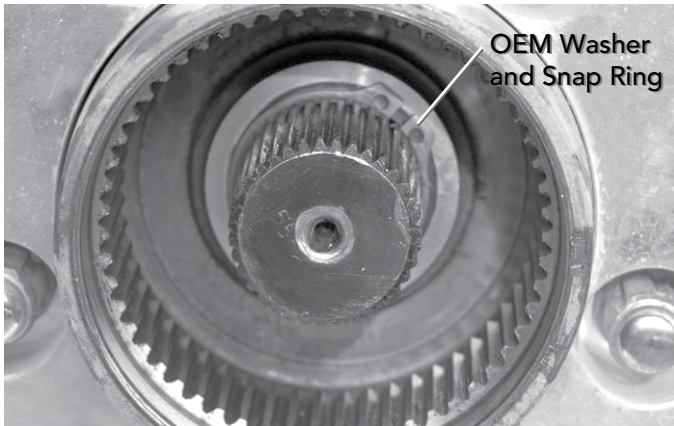

4. Before installing lock-outs inspect the splines inside the hub to verify there are no burrs, rust or any other debris. Thoroughly clean and deburr the inner portions of the hub.

*Note: Spline damage will result in improper lockout function. Replace outer wheel hub as needed.*

5. Lubricate the hub spline and axle shaft with high pressure grease.

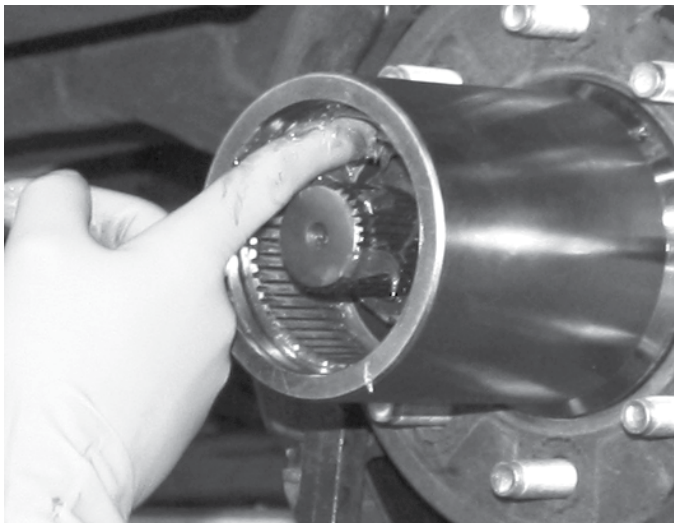

## **D60 Hardcore Locking Hub Installation Instructions**

---

*Note: All components must be lubricated with grease when instructed to do so. Photos may not show grease on all components.*

6. Insert the spring retainer into the hub. The flat end of the retainer must face out as shown. (Retainer not included in the YHC70004 kit.)

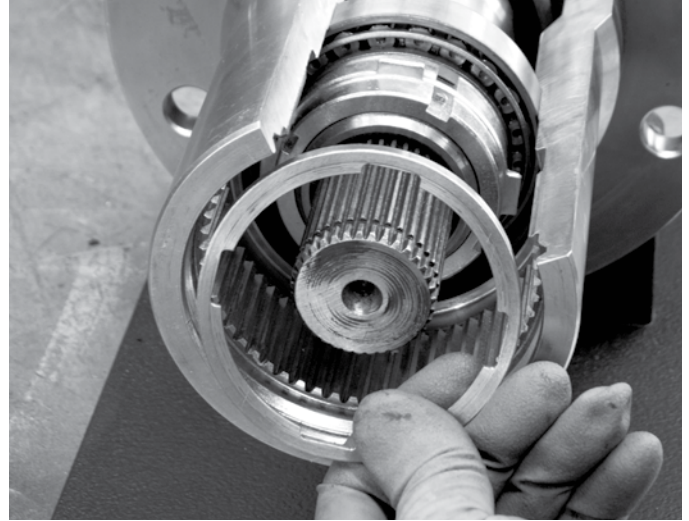

7. Assemble coil spring into hub. The spring is symmetrical therefore can go in either end first. The spring will seat on the spring retainer if being used on a standard spindle, hub assembly. The spring will sit inside the outer hub if being used on a unit bearing assembly. Verify the spring is free to compress and does not interfere with the spindle nuts, axle, or any other item inside the hub.

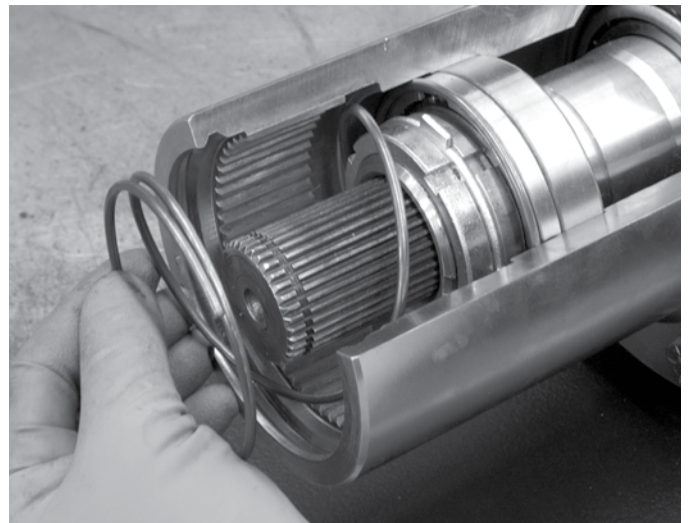



## **D60 Hardcore Locking Hub Installation Instructions**

---

8. Coat the spacer with high pressure grease on all surfaces. Assemble spacer over the outer axle and seat it against the spindle or snap ring. Different spacer heights are available for different hub applications. Verify the Lockout assembly part number and proper application before moving forward.

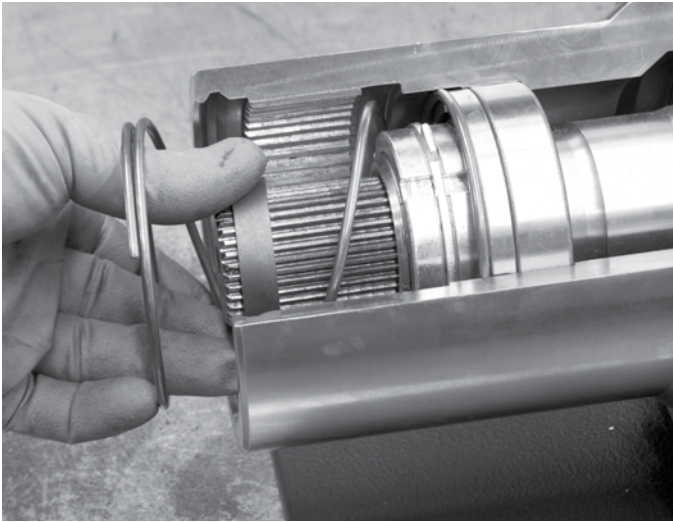

9. Coat the coupler and driver with high pressure grease on all surfaces. Mesh the driver and coupler pieces together and install into the hub, over the axle as shown. The hub and or axle may need to be rotated during assembly to properly align the splines. Pressure must be kept against the driver coupler assembly while installing them into the hub.

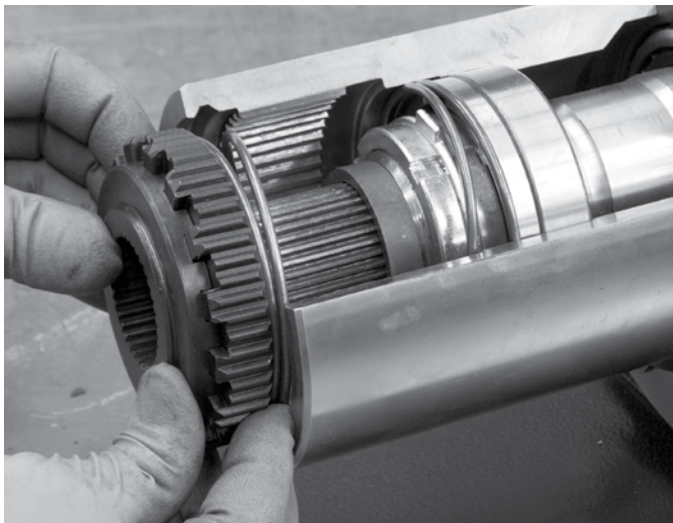

## **D60 Hardcore Locking Hub Installation Instructions**

---

10. While fully compressing the assembly install the axle snap ring if applicable. Assure the snap ring fully seats into the groove on the outer shaft. If no outer snap ring groove exists proceed to the next step in assembly.

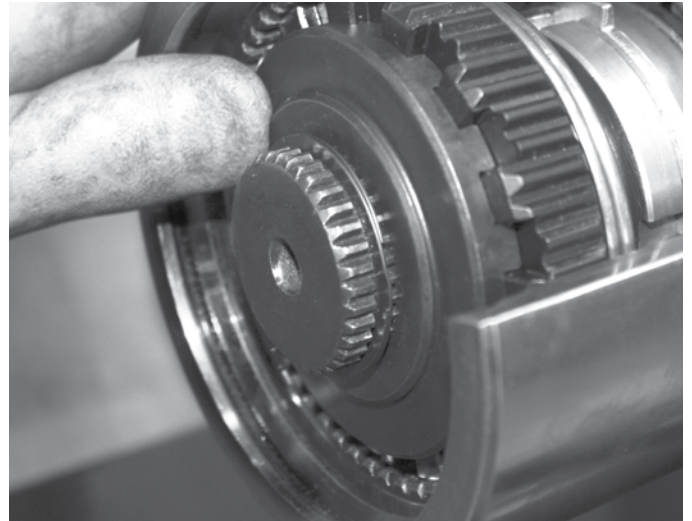

11. Install the Cam Spacer into the retainer plate by Aligning the ears on the cam spacer with the notches in the retainer plate as shown. Coat both pieces with high pressure grease. Place the two components into the hub.



## D60 Hardcore Locking Hub Installation Instructions

12. Install the hub snap ring into the hub. A small amount of force may be necessary to compress the cam spacer into the hub to allow extra clearance for snap ring installation. Be sure snap ring is fully seated into the snap ring groove of the hub.

*Note: The installed driver must have less than 0.200" float between the retainer plate and spacer when installed into the hub. If more than 0.200" of float can be measured check the part number against the application guide found on page 2 and contact Technical Service.*

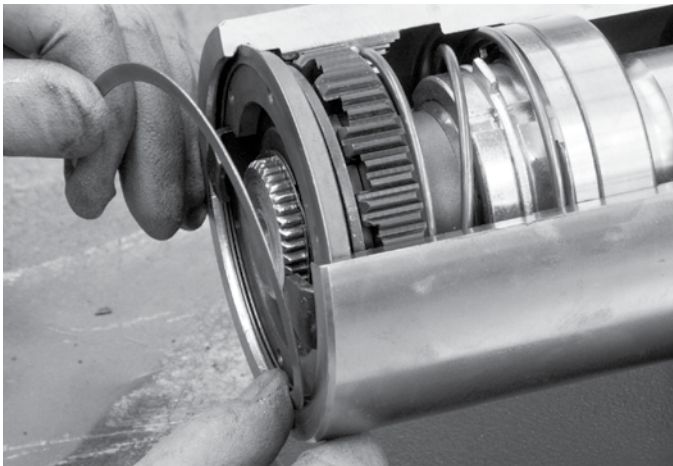

13. Test for proper operation of the cam spacer by compressing the spacer into the hub several times. The cam spacer must freely slide in and out of the hub assembly and return fully seated against the retainer plate. If any binding or resistance occurs disassemble all components and check for proper assembly.

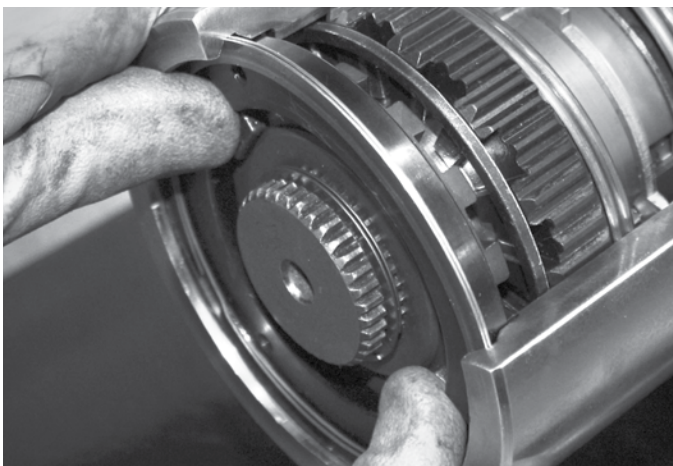

## D60 Hardcore Locking Hub Installation Instructions

14. Apply a generous amount high pressure grease to the ears of the cam spacer.

15. Apply o-ring lube to the o-rings and assemble them onto the selector and bezel as shown.

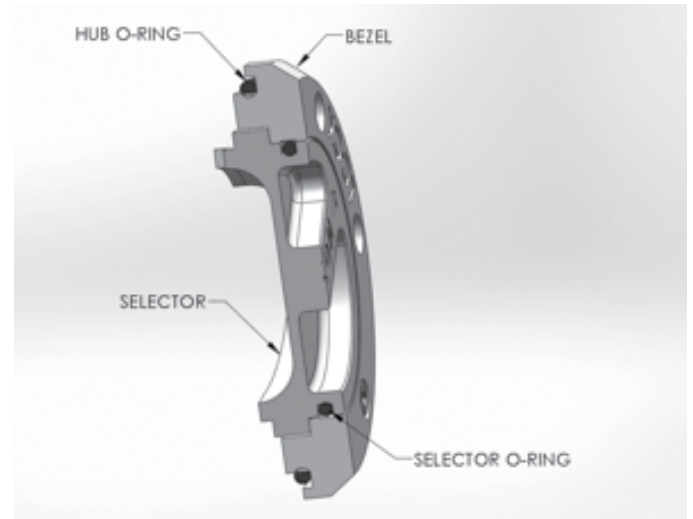

16. Align the arrow on the selector with "LOCK" label on the Bezel. Install the Bezel, Selector assembly into the hub. The cam spacer must align into the cutouts on the backside of the bezel as shown. If items are not aligned check all assembly steps.

*Note: All components are designed to align during installation. No force is required when installing the bezel and selector. If the assembly requires force to compress the cam spacer contact Technical Service.*

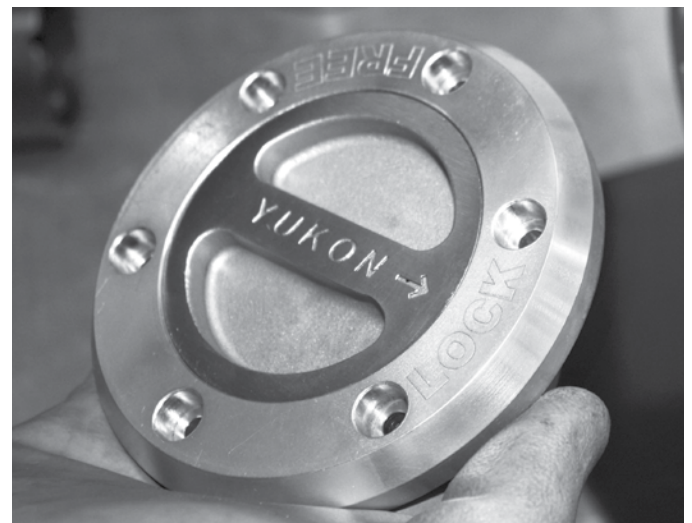

## D60 Hardcore Locking Hub Installation Instructions

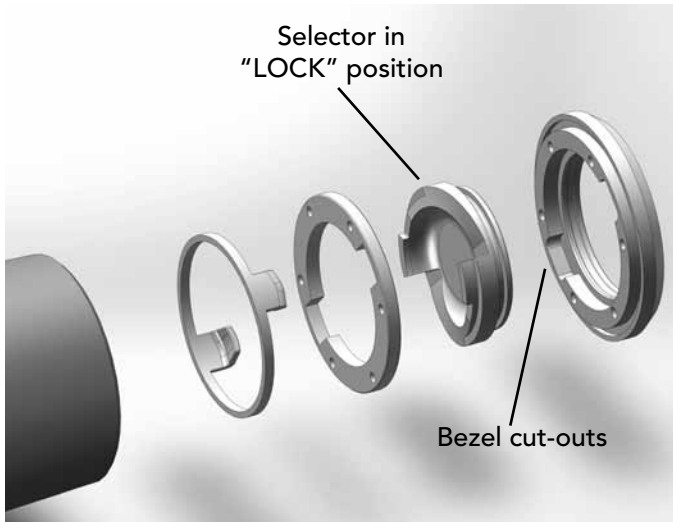

17. Install the Nylon washers over the 10-24 bolts and apply 1 drop of Loctite 242 or equivalent onto the threads of the lockout bolts.

18. Install bolts and tighten to 22 in-lbs. Do not over torque the bolts. Over torquing the bolts may result in improper hub function and damage to the lockout components.

### TO CHECK FOR PROPER OPERATION:

19. To check for proper engagement, dial both hubs to the "LOCK" position and raise the front two wheels in the air. If the drive line spins when you turn the tire then the hubs are engaging properly.

20. To check for proper disengagement, dial the lifted wheels hubs to "FREE" position and spin the lifted wheels. If the driveline does not turn and you hear no ratcheting sound then the hub is disengaging properly.

*Note: The arrow of the selector must align to the center of the "FREE" and "LOCK" indicators. If the arrow does not align to the center of the indicators, check all installation steps. Extra force may be required to fully turn the selector handle.*

**DO NOT DRIVE LOCKING HUBS IF THE ARROW IS NOT DIRECTLY CENTERED OVER THE INDICATORS.**



## D60 Hardcore Locking Hub Installation Instructions

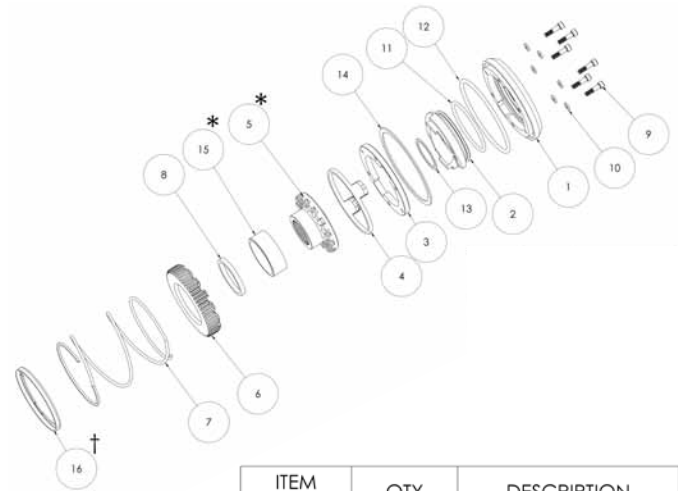

ITEM NO.	QTY	DESCRIPTION
1	2	BEZEL
2	2	SELECTOR
3	2	RETAINER PLATE
4	2	CAM SPACER
5	2	DRIVER
6	2	COUPLER
7	2	SPRING
8	2	SPACER
9	12	10-24, 3/4" SHCS
10	12	NYLON WASHER
11	2	SELECTOR O-RING
12	2	HUB O-RING
13	2	AXLE SNAP RING
14	2	HUB SNAP RING
15	2	BUSHING
16	2	SPRING RETAINER

\* NOTE: BUSHINGS ARE PRESS FIT ONTO DRIVERS  
† YHC70004 DOES NOT INCLUDE SPRING RETAINERS

### FOR YOUR RECORDS

Name \_\_\_\_\_

Date \_\_\_\_\_

Invoice Number \_\_\_\_\_

Yukon Part Number \_\_\_\_\_







## ***Limited Lifetime Warranty***

### **D60 Hardcore Locking Hubs®**

#### **WARRANTY DETAILS**

Yukon Gear & Axle® (“Yukon”) warrants the original retail purchaser that the Hardcore Locking Hubs will be free from defects in materials and workmanship for as long as you own the vehicle. This warranty is not transferable to another party. Yukon makes no other warranty of any kind, express or implied. All other warranties, including but not limited to an implied warranty of merchantability or fitness for a particular purpose, are excluded. This warranty is offered provided that the Yukon product has been installed and maintained in accordance with Yukon instructions, and that it has not been subject to modification, accident, abnormal use or misuse. Upon notification of a warranty claim, Yukon shall investigate the claim of defect, and, in the event of a verified defect, shall, at their sole choice, either repair the defective product, replace it, or refund the purchase price.

This warranty does not cover, and Yukon shall not be liable for, incidental or consequential damages, including loss of time, road service charges, labor charges, inconvenience, loss of vehicle use, loss of revenues, or loss or damage to personal property (including loss or damage to vehicle parts due to the failure of the Yukon product). In addition, this warranty does not cover, and Yukon shall not be liable for, any undertaking, representation, or agreements made by dealers or other third parties selling Yukon Gear & Axle® products, except where such agreements are within the provisions of this Warranty statement. Also, this warranty does not cover damage to the axle caused by or facilitated by failure of a non-Yukon component.

This agreement offers you specific legal rights. You may also have other rights which vary from state to state.